



For Use in CCO Written Examinations

REFERENCE BOOKLET RIGGER

This Reference Booklet has been produced and adapted from various manufacturers' data and is for use in CCO Written Examinations.

This supplement is not to be used for any other purpose.

Copyright 2009–2014 National Commission for the Certification of Crane Operators (NCCCO). All rights reserved. This document may not be reproduced in whole or in part without the express written permission of the manufacturer and the consent of NCCCO.

HOLD HARMLESS/RELEASE/DISCLAIMER AGREEMENT

The reading and/or using person or entities using this publication for and in consideration of the assistance, cooperation, and information given by the National Commission for the Certification of Crane Operators (NCCCO) in this publication, *Rigger Reference Booklet*, the receipt of which is acknowledged, does hereby and for all future time have released, hold harmless from any liability, and forever discharged for itself, its administrators and assigns the said NCCCO from all and any manner of action or demands whatsoever in law, in admiralty, or in equity, which against the said NCCCO anyone ever had, now have, or which shall be later claimed. This agreement relates specifically to any cause of action arising out of the publication, information provided, subsequent conduct, and any use of the information provided in this publication and related uses or demonstrations of skills,

methods, and techniques cited in the publication. This mutually beneficial release and hold harmless agreement may not be changed orally and exists in perpetuity. NCCCO generally and specifically disclaims any warranty, merchantability of intended or unintended use, or liability for use of the in the information. This publication is issued solely as a public service to improve the lifting industry and promote public safety.

Copyright 2009–2014 by the National Commission for the Certification of Crane Operators. All rights reserved. No part of this book may be reproduced or transmitted in any form or by any means, electronic or mechanical, including photocopying, recording, or by any information storage and retrieval system, without prior written permission from the publisher. For information, contact the publisher, National Commission for the Certification of Crane Operators.

General Data

1

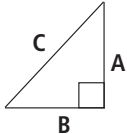
$A^2 + B^2 = C^2$ $C^2 - A^2 = B^2$ $C^2 - B^2 = A^2$ Area of a triangle = $\frac{1}{2} \times A \times B$		<ul style="list-style-type: none"> d = diameter L = length W = width Circumference = $\pi \times d$ Volume of rectangular prism = $L \times W \times H$ 	<ul style="list-style-type: none"> r = radius H = height π or Pi = 3.14 Area of a circle = $\pi \times r^2$ Area of a square = $L \times W$
Wire Rope Sling D/d Ratio Strength Efficiencies 25:1 = 1.00 20:1 = .92 15:1 = .88 10:1 = .86 4:1 = .75 2:1 = .65 1:1 = .50	1 yard = 3 ft. = 36 in. = .91 meter 1 meter = 1.09 yd. = 3.28 ft. = 39.37 in. 1 ton (short) = .891 long ton = .91 metric ton = 2,000 lbs. = 907 kg 1 ton (metric) = 1.1 short ton = .98 long ton = 2,204 lb. = 1,000 kg 1 pound = .45 kg 1 kg = 1,000 grams = 2.2 lb. 1 gallon (U.S. liq.) = 4 qt. = 3.8 liters 1 liter = .264 gallon (U.S.) = 1.06 qt. 1 KIP = 1,000 lb.		

Calculating Load Weights

2

Materials and Liquids - Pounds / cu. ft.		Pounds / sq. ft.		Pounds / gallon	
Aluminum	168	Iron Casting	460	Steel plate	
Asbestos	153	Lead	710	• 1/8 inch	5
Asphalt	80	Lumber—Fir	40	• 1/4 inch	10
Brass	521	Lumber—Oak	62	• 1/2 inch	20
Brick	120	Lumber—Railroad Ties	50	• 1 inch	40
Bronze	500	Oil, Motor	58	Aluminum plate	
Coal	56	Paper	60	• 1/8 inch	1.75
Concrete, Reinforced	150	Portland Cement	94	• 1/4 inch	3.50
Crushed Rock	95	River Sand	120	Lumber	
Diesel	53	Rubber	94	• 3/4 inch Fir	2.5
Dry Earth, Loose	74	Steel	480	• 3/4 inch Oak	4.0
Gasoline	45	Water	62		
Glass	160	Zinc	437		

Gasoline	6.0
Diesel	7.0
Water	8.3

7.5 gallons of liquid to a cubic foot
27 cubic feet to a cubic yard

Load Factors & Weight Distribution

3

$$\text{Sling Tension} = \frac{\text{Sling Length (L)}}{\text{Sling Height (H)}} \times \text{share of load wt.}$$

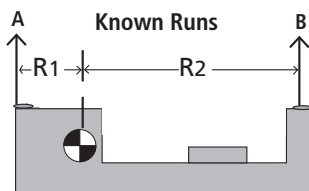

Share of Load Wt. @ A	Share of Load Wt. @ B	Legend
$R_1 + R_2 = TS$ $\frac{R_2}{TS} = P$ $P \times W = \text{Share of Load Wt. @ A}$	$R_1 + R_2 = TS$ $\frac{R_1}{TS} = P$ $P \times W = \text{Share of Load Wt. @ B}$	$R_1 = \text{Run, Side 1}$ $R_2 = \text{Run, Side 2}$ $TS = \text{Total Span}$ $P = \text{Percentage}$ $W = \text{Weight of Load}$

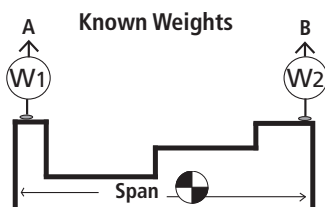

CG In Feet From A	CG In Feet From B	Legend
$W_1 + W_2 = TW$ $\frac{W_2}{TW} = P$ $P \times S = \text{CG in ft. from A}$	$W_1 + W_2 = TW$ $\frac{W_1}{TW} = P$ $P \times S = \text{CG in ft. from B}$	$W_1 = \text{Weight at A}$ $W_2 = \text{Weight at B}$ $TW = \text{Total Weight}$ $P = \text{Percentage}$ $S = \text{Span}$

Level & Incline Planes

4

Legend	Formulas
W = Weight of load	Level: $F = CF \times W$
CF = Coefficient of Friction	
F = Force required to move load	Uphill: $F = (CF \times R/L \times W) + (W \times H/L)$
H = Height in feet	
R = Run, horizontal distance in feet	Downhill: $F = (CF \times R/L \times W) - (W \times H/L)$
L = Length of ramp in feet	

Coefficients of Friction [For Estimation Only]

Concrete on concrete	.65	Wood on metal	.30	Steel on steel	.10
Metal on concrete	.60	Cast iron on steel	.25	Load on wheels	.05
Wood on wood	.50	Continuous lubricated surface	.15	Load on ice	.01
Wood on concrete	.45			Load on air	.002

Level Pick Points

5

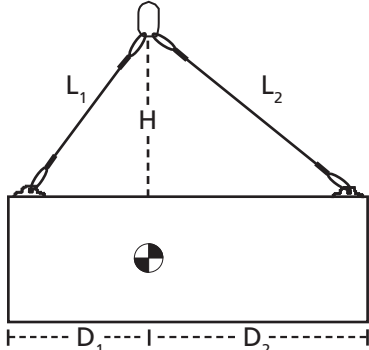
Legend	
W = Load Weight	
D ₁ = Distance of Side 1	
D ₂ = Distance of Side 2	
L ₁ = Sling Length, Side 1	
L ₂ = Sling Length, Side 2	
H = Vertical Height	
TL ₁ = Tension, Length 1	
TL ₂ = Tension, Length 2	

$$TL_1 = \frac{L_1 \times W \times D_2}{H \times (D_1 + D_2)}$$

$$TL_2 = \frac{L_2 \times W \times D_1}{H \times (D_1 + D_2)}$$

Off-level Pick Points

6

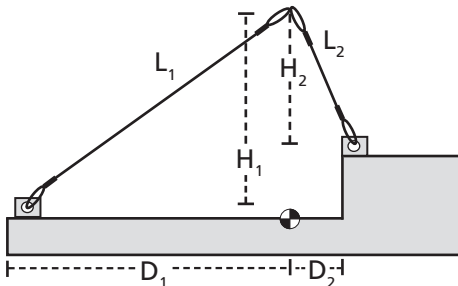
Legend	
W = Load Weight	
D ₁ = Distance of Side 1	
D ₂ = Distance of Side 2	
L ₁ = Sling Length, Side 1	
L ₂ = Sling Length, Side 2	
H ₁ = Vertical Height, Side 1	
H ₂ = Vertical Height, Side 2	
TL ₁ = Tension, Length 1	
TL ₂ = Tension, Length 2	

$$TL_1 = \frac{W \times D_2 \times L_1}{(D_2 \times H_1) + (D_1 \times H_2)}$$

$$TL_2 = \frac{W \times D_1 \times L_2}{(D_2 \times H_1) + (D_1 \times H_2)}$$

Block & Fairlead Loading

7

Full Included Angle	Block Factor
180	0.00
170	0.17
160	0.35
150	0.52
140	0.68
130	0.84
120	1.00
110	1.15
100	1.29
90	1.41
80	1.53
70	1.64
60	1.73
50	1.81
40	1.87
30	1.93
20	1.97
10	1.99
0	2.00

Example

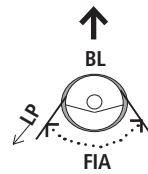

BL = Block Load
 BF = Block Factor
 LP = Line Pull
 FIA = Full Included Angle

Formula
 BL = BF × LP

Wire Rope EIPS/IWRC Sling Capacities (lb.)



Mechanical Splice

8

Size in inches						
1/4	1,300	960	2,600	2,200	1,820	1,300
5/16	2,000	1,480	4,000	3,400	2,800	2,000
3/8	2,800	2,200	5,600	5,000	4,000	2,800
7/16	3,800	2,800	7,600	6,800	5,400	3,800
1/2	5,000	3,800	10,000	8,800	7,200	5,000
9/16	6,400	4,800	12,800	11,000	9,000	6,400
5/8	7,800	5,800	15,600	13,600	11,000	7,800
3/4	11,200	8,200	22,400	19,400	15,800	11,200
7/8	15,200	11,200	30,400	26,000	22,000	15,200
1	19,600	14,400	39,200	34,000	28,000	19,600
1-1/8	24,000	18,000	48,000	42,000	34,000	24,000
1-1/4	30,000	22,500	60,000	52,000	42,000	30,000

3-Part Braided Wire Rope Sling Capacities (tons)

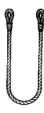

9

Finished Diameter (inches)	Composed of 3 parts of EIP Rope (inches)				Weight Per Ft. Approx. (pounds)
1/2	1/4	1.7	1.3	3.4	.44
5/8	5/16	2.6	1.9	5.2	.68
3/4	3/8	3.6	2.7	7.2	.99
7/8	7/16	4.9	3.7	9.8	1.33
1	1/2	6.4	4.8	12.8	1.75
1-1/8	9/16	8.0	6.0	16.0	2.24
1-3/4	7/8	19.0	14.3	36.0	5.40
2-1/4	1-1/8	31.2	23.4	62.4	8.90
2-3/4	1-3/8	46.0	34.5	92.0	13.30
3-1/4	1-5/8	63.4	47.6	126.8	18.50
4	2	95.0	71.2	190.0	28.00
4-1/2	2-1/4	118.0	88.5	236.0	35.60
5	2-1/2	145.0	109.0	290.0	44.00

Basket-rated capacities based on D/d ratio of five times the wire rope's finished diameter.

9-Part Braided Wire Rope Sling Capacities (tons)







10

Finished Diameter (inches)	Composed of 9 parts of EIP Rope (inches)			
1/2	1/8	1.4	1.0	2.8
5/8	5/32	2.0	1.5	4.0
3/4	3/16	3.0	2.2	6.0
7/8	7/32	4.0	3.0	8.0
1	1/4	4.8	3.6	9.6
1-1/2	3/8	10.5	7.8	21.0
2	1/2	19.1	14.3	38.2
2-1/2	5/8	29.6	22.2	59.2
3	3/4	42.3	31.7	84.6
3-1/2	7/8	57.3	42.9	114.6
4	1	74.4	55.8	148.4
4-1/2	1-1/8	93.6	60.2	187.2

Basket-rated capacities based on D/d ratio of five times the wire rope's finished diameter.

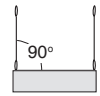



Synthetic Sling Capacities (lbs.)

11

	Size or Code						
Web Eye / Eye	1-9-1	1,600	1,280	3,200	2,770	2,260	1,600
	1-9-2	3,200	2,560	6,400	5,540	4,452	3,200
	1-9-3	4,800	3,840	9,600	8,320	6,780	4,800
	1-9-4	6,400	5,120	12,800	11,090	9,040	6,400
	2-9-3	8,880	7,100	17,760	15,390	12,540	8,880
	2-9-4	11,520	9,210	23,040	19,960	16,270	11,520
Polyester Round	1	2,600	2,100	5,200	4,500	3,600	2,600
	2	5,300	4,200	10,600	9,100	7,500	5,300
	3	8,400	6,700	16,800	14,500	11,800	8,400
	4	10,600	8,500	21,200	18,300	14,900	10,600
	5	13,200	10,600	26,400	22,800	18,600	13,200
	6	16,800	13,400	33,600	29,100	23,700	16,800

High Capacity Round Sling Capacities (lbs.)*

12



Dual-Path Model						Approx. Body Width (inches)
DP 1000	10,000	8,000	20,000	17,320	14,140	3
DP 1500	15,000	12,000	30,000	25,980	21,210	3
DP 2000	20,000	16,000	40,000	34,640	28,280	3
DP 2500	25,000	20,000	50,000	43,300	35,350	3
DP 3000	30,000	24,000	60,000	51,960	42,420	4
DP 4000	40,000	32,000	80,000	69,280	56,560	4
DP 5000	50,000	40,000	100,000	86,600	70,700	5
DP 6000	60,000	48,000	120,000	103,920	84,840	5
DP 7000	70,000	56,000	140,000	121,240	98,980	5
DP 8500	85,000	68,000	170,000	147,220	120,190	6
DP 10000	100,000	80,000	200,000	173,200	141,400	6
DP 12500	125,000	100,000	250,000	216,500	176,750	8
DP 15000	150,000	120,000	300,000	259,800	212,100	8
DP 17500	175,000	140,000	350,000	303,100	247,450	10
DP 20000	200,000	160,000	400,000	346,400	282,800	10
DP 25000	250,000	200,000	500,000	433,000	353,500	10
DP 27500	275,000	220,000	550,000	476,300	388,850	12
DP 30000	300,000	240,000	600,000	519,600	424,200	12
DP 40000	400,000	320,000	800,000	692,800	565,600	14
DP 50000	500,000	400,000	1,000,000	866,000	707,000	16

*Capacities shown include both paths and are for one complete sling; sling ratings based on fittings of equal or greater capacity.

Alloy Chain Sling Capacities (lbs.)

13

Grade 80

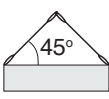
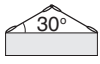
Size in inches	Single Leg		Two Leg Slings			Three & Four Leg Slings	
						60°	45°
9/32	3,500	2,800	6,100	4,900	3,500	9,150	7,400
3/8	7,100	5,700	12,300	10,000	7,100	18,400	15,100
1/2	12,000	9,600	20,800	17,000	12,000	31,200	25,500
5/8	18,100	14,500	31,300	25,600	18,100	47,000	38,400
3/4	28,300	22,600	49,000	40,000	28,300	73,500	60,000
7/8	34,200	27,400	59,200	48,400	34,200	88,900	72,500
1	47,700	38,200	82,600	67,400	47,700	123,900	101,200
1-1/4	72,300	57,800	125,200	102,200	72,300	187,800	153,400

Grade 100

9/32	4,300	3,500	7,400	6,100	4,300	11,200	9,100
3/8	8,800	7,100	15,200	12,400	8,800	22,900	18,700
1/2	15,000	12,000	26,000	21,200	15,000	39,000	31,800
5/8	22,600	18,100	39,100	32,000	22,600	58,700	47,900
3/4	35,300	28,300	61,100	49,900	35,300	91,700	74,900
7/8	42,700	34,200	74,000	60,400	42,700	110,900	90,600

Rigging Hardware Capacities (lbs.)

14

Size in inches	Shoulder Eye Bolt		Turnbuckle Eye or Jaw	Shackle SP Anchor	Wire Rope Clip			Swivel Hoist Rings WLL (lbs.)	Alloy Master Links WLL (lbs.)
	In Line	45 deg.			Min. # clips	Turnback (inches)	Torque (ft. lbs.)		
1/4	500	125	500	1,000	2	4.75	15	-----	-----
5/16	800	200	800	1,500	2	5.25	30	800	-----
3/8	1,200	300	1,200	2,000	2	6.50	45	1,000	-----
7/16	-----	-----	-----	3,000	2	7.00	65	-----	-----
1/2	2,200	550	2,200	4,000	3	11.50	65	2,500	7,400
9/16	-----	-----	-----	-----	3	12.00	95	-----	-----
5/8	3,500	875	3,500	6,500	3	12.00	95	4,000	9,000
3/4	5,200	1,300	5,200	9,500	4	18.00	130	5,000	12,300
7/8	7,200	1,800	7,200	13,000	4	19.00	225	8,000	15,200
1	10,000	2,500	10,000	17,000	5	26.00	225	10,000	26,000
1-1/8	-----	-----	-----	19,000	6	34.00	225	-----	-----
1-1/4	15,200	3,800	15,200	24,000	7	44.00	360	15,000	39,100
1-1/2	-----	-----	-----	-----	-----	-----	-----	-----	61,100
2	-----	-----	-----	-----	-----	-----	-----	-----	102,600
2-1/2	-----	-----	-----	-----	-----	-----	-----	-----	160,000
3	-----	-----	-----	-----	-----	-----	-----	-----	228,000
3-1/2	-----	-----	-----	-----	-----	-----	-----	-----	279,000
4	-----	-----	-----	-----	-----	-----	-----	-----	373,000

Synthetic Sling Shackle

15

Round Sling Size (No.)	Web Slings*		Working Load Limit (Tons)
	Webbing Width (in.)	Eye Width (in.)	
1	2	2	3-1/4
2	2	2	3-1/4
3	3	1.5	4-1/2
4	4	2	6-1/4
5	6	3	8-1/2
6	6	3	8-1/2

* NOTE: Designed for use with Type III, (Eye & Eye), Class 7, 2 Ply web slings. For 3" and larger webbing width, tapered eye is required.

Wide Body Shackles

16

Working Load Limit (Tons)	Weight Each (lbs.)	Dimensions in Inches			"B" is spread between shackle ears "D" is shackle pin diameter Effective Body Diameter is the diameter to use when calculating D/d ratio for sling: D = effective body diameter d = sling diameter
		B +/- .02	D +/- .02	Effective Body Diameter	
7	4.0	1.25	0.88	2.1	
12.5	8.8	1.69	1.13	2.4	
18	14.9	2.03	1.38	2.8	
30	26.5	2.37	1.63	4.1	
40	35.0	2.88	2.00	3.6	
55	68.0	3.25	2.25	4.3	
75	99.0	4.13	2.75	5.9	
125	161	5.12	3.15	6.8	
200	370	5.91	4.12	8.9	
300	847	7.38	5.25	11.8	
400	1130	8.66	6.30	14.3	